

TG301

WYCINANE LASEROWO

145 EL.

SAMOLOT

Drewniane puzzle 3D

1

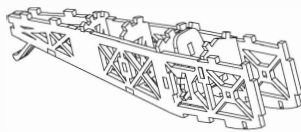
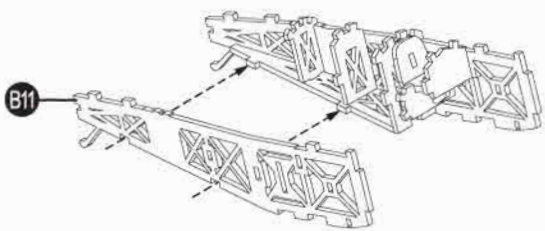
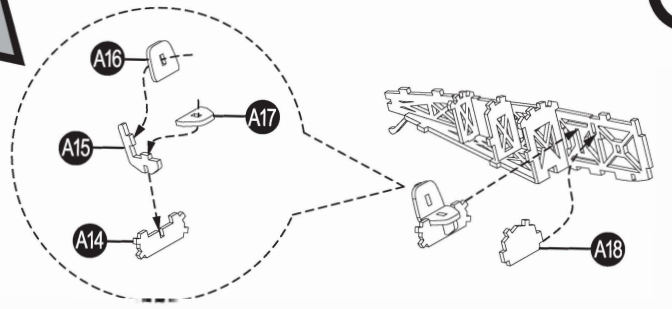
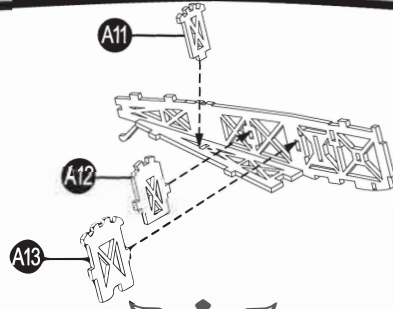
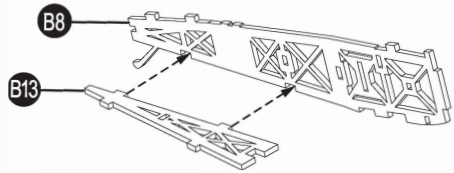

2

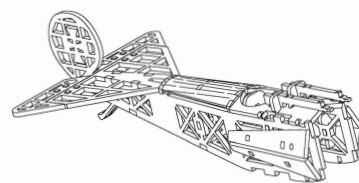
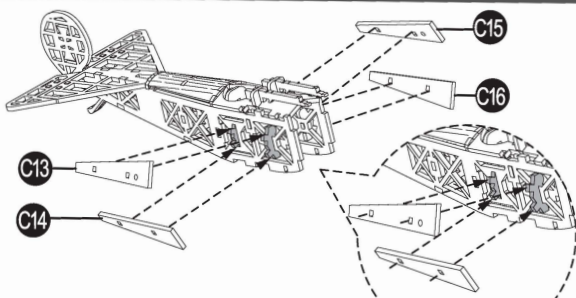
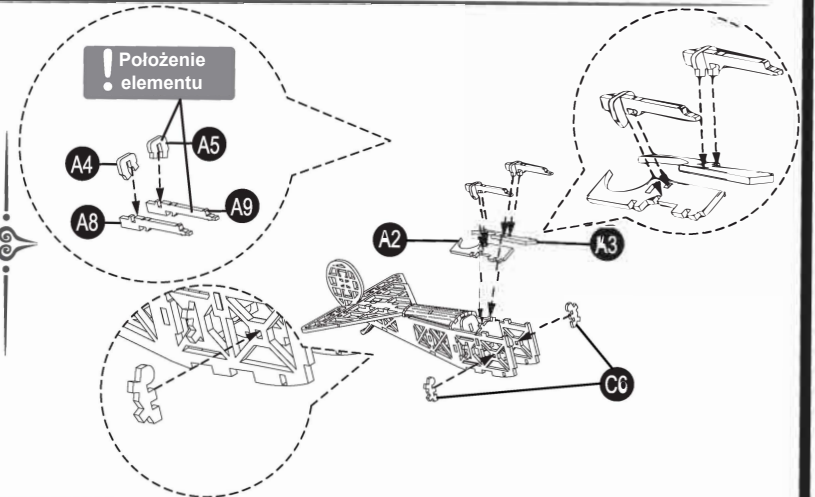
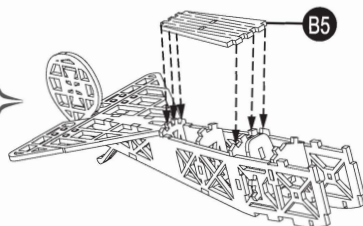
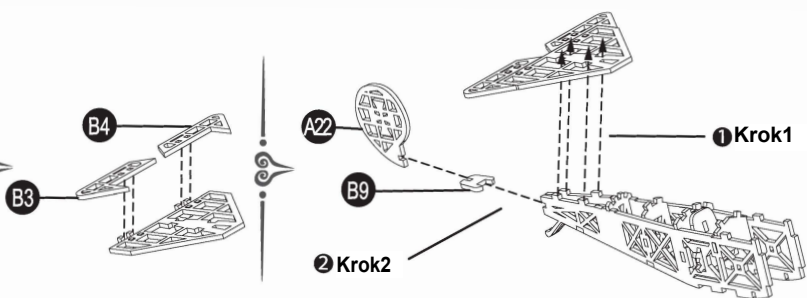
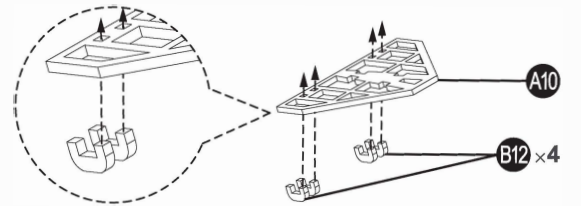

3

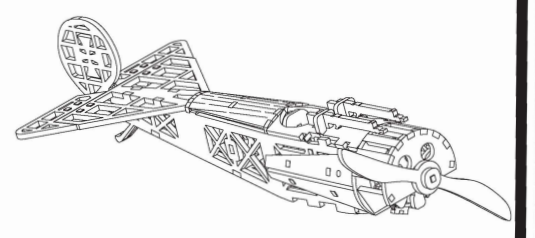
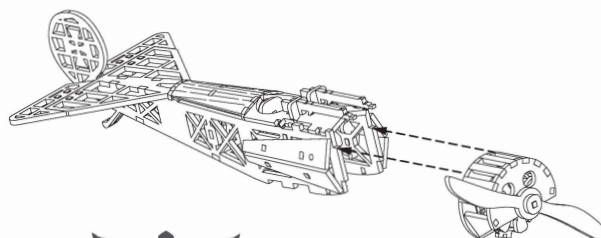
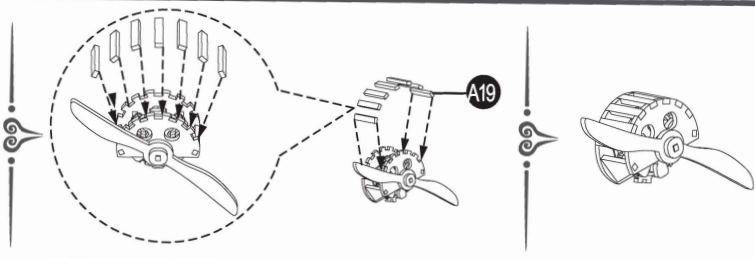
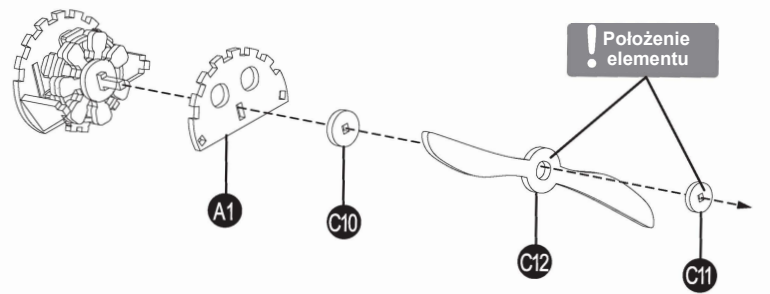
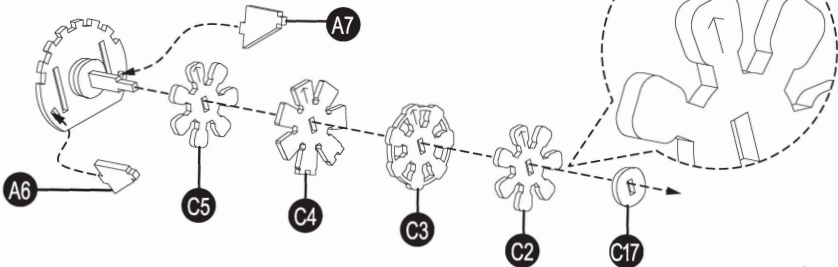
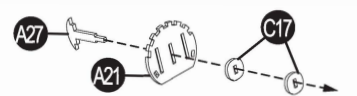

4

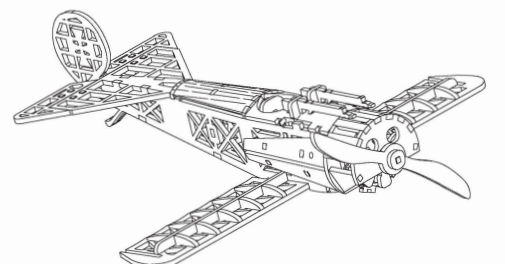
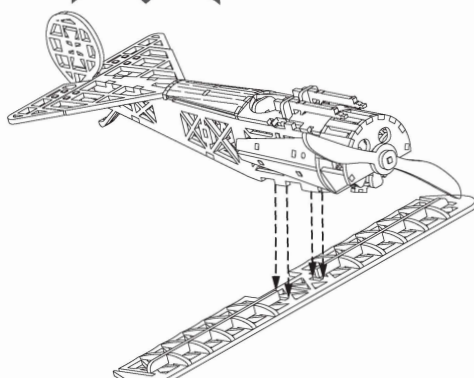
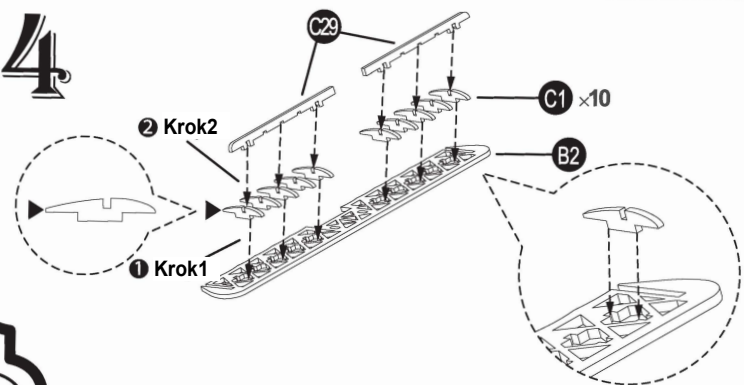

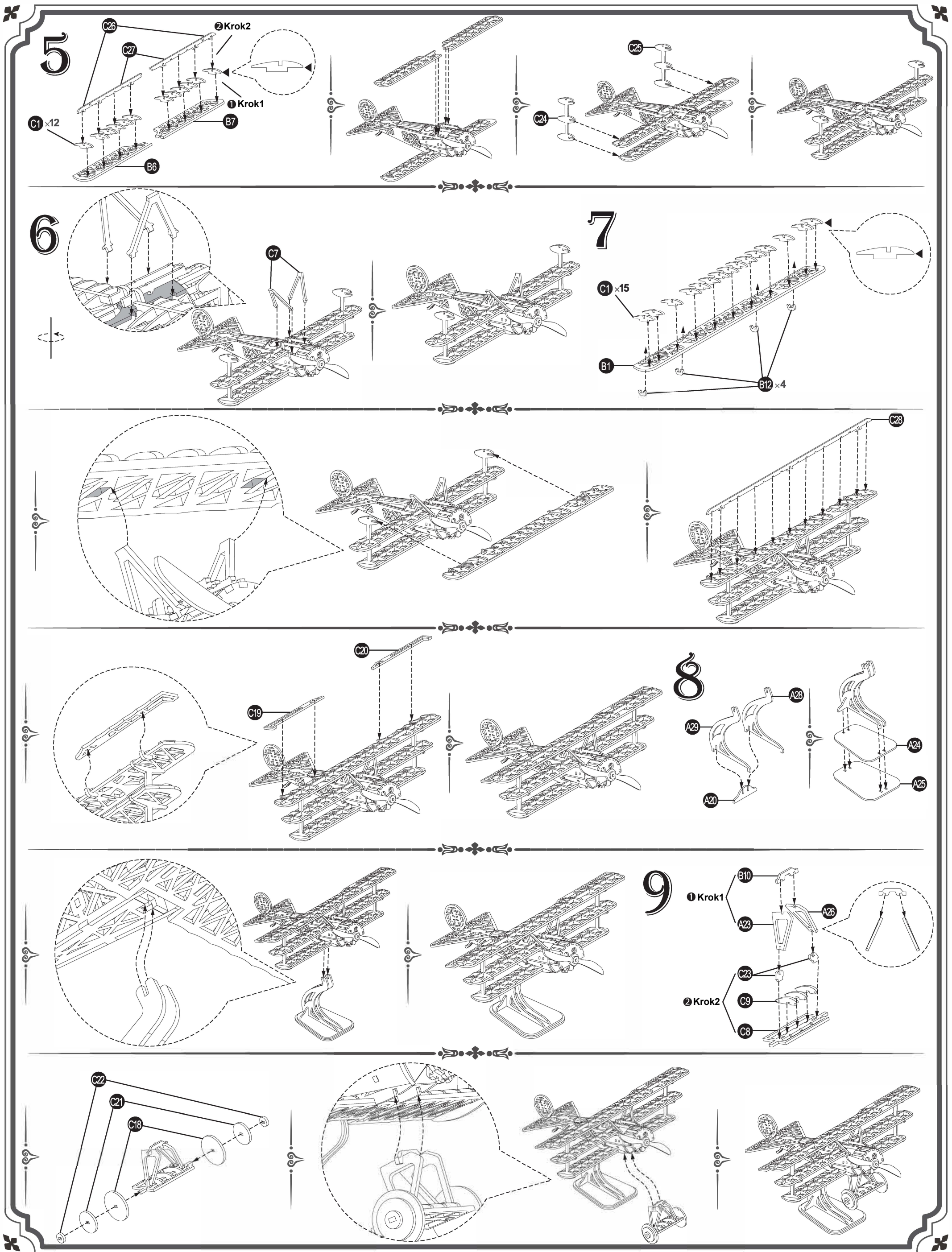

UWAGA:

Produkt przeznaczony dla osób powyżej 8 lat.
Dzieci muszą składać pod opieką dorosłych.

Ryzyko zadławienia-małe części

OSTRZEŻENIE:

Trzymać z dala od ognia, przechowywać w suchym miejscu.

Nie używać środków chemicznych do czyszczenia produktu.

W razie potrzeby użyj papieru ściernego, aby wyrównać powierzchnię.

WYPRODUKOWANO W CHINACH

DYSTRYBUTOR:

Kronos S.C. B. Ekiert, Ł. Pieprzyk, D. Włodarczak

Ul. Włókniarzy 1

63-100 Śrem

www.robotime.com.pl

