

SHIELD MAN

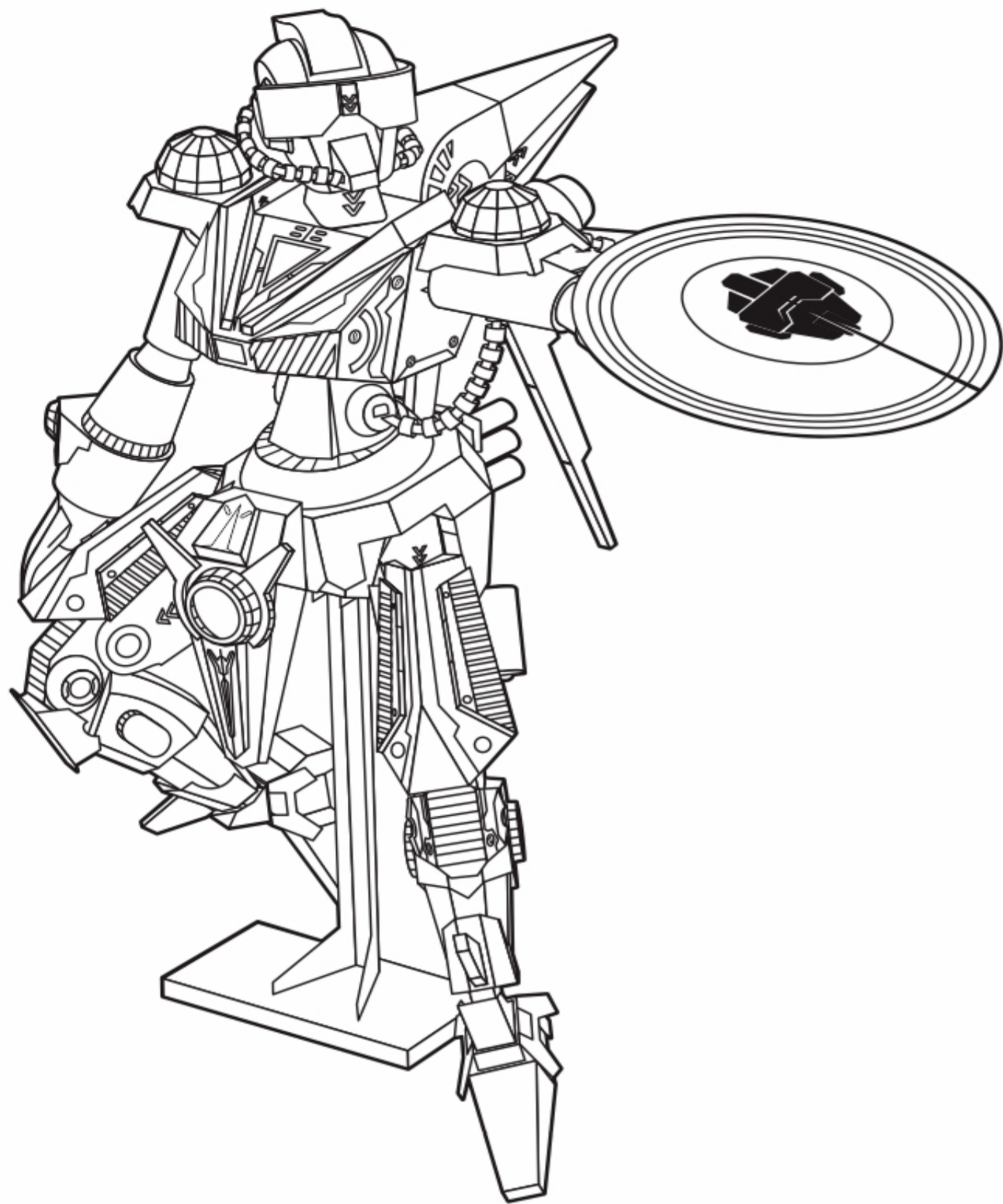

Wstęp:

Narzędzia:

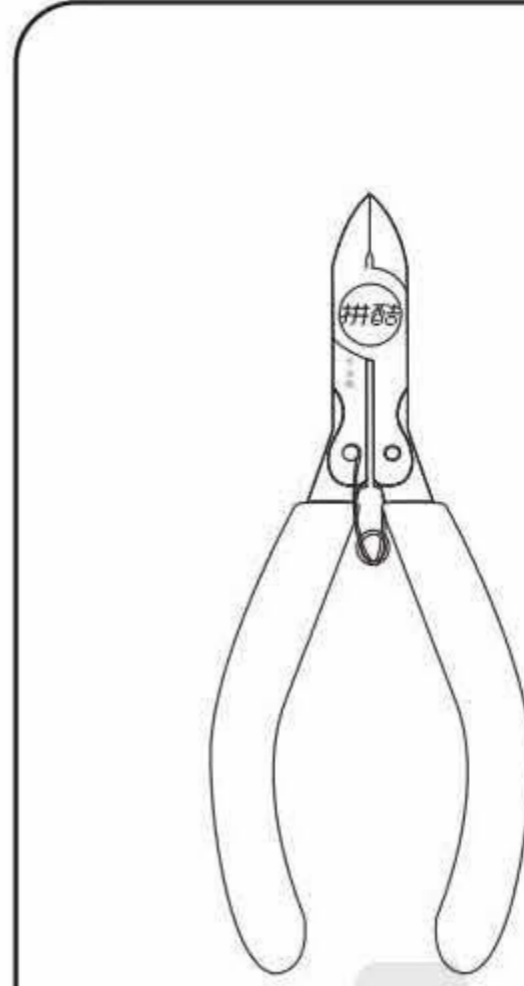

Obcążki

Wycinanie elementów z metalowych arkuszy.

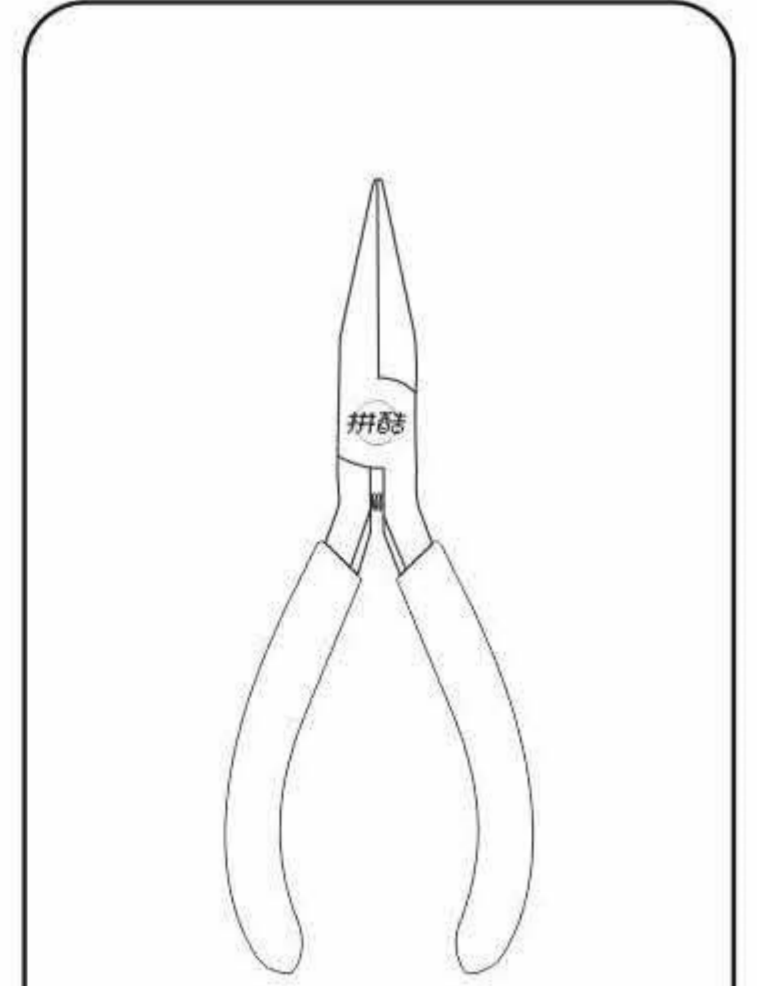

Szczypce

Zaginanie i formowanie elementów.

Zalecane jest użycie oryginalnych narzędzi Piececool, które są trwałe i wygodne, ponieważ zostały zaprojektowane do budowy metalowych modeli.



UWAGA: zachowaj ostrożność podczas wycinania elementów, ponieważ metalowe krawędzie mogą skaleczyć skórę.

Wycinanie elementów:



Użyj obcążków, aby przeciąć łącznik i oddzielić elementy od metalowego arkusza.

Opis elementów:

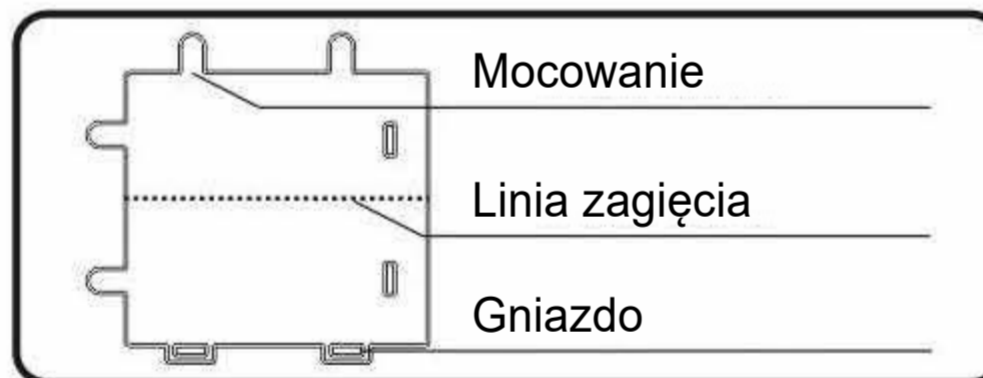

Zwróć uwagę na mocowanie, linię zagięcia oraz gniazdo podczas montażu elementów.

Zaginanie elementów:

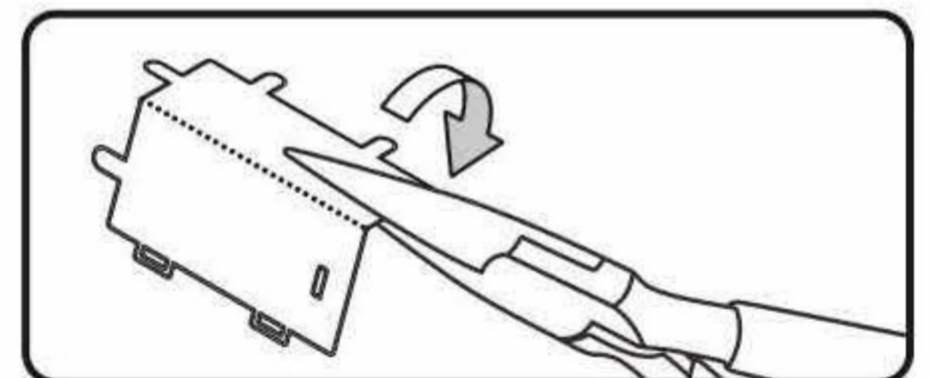

Użyj szczypców, aby zagiąć metalowe elementy i uformować model.

Mocowanie elementów:

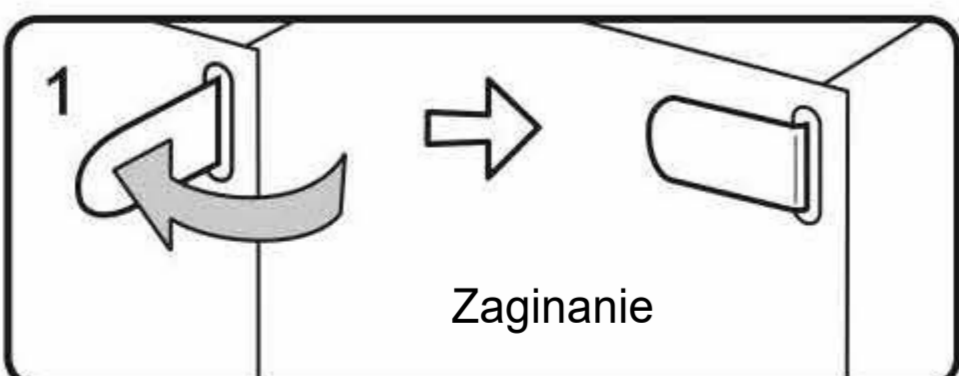

Umieść mocowanie w gnieździe, następnie zagnij pod kątem 90 stopni.

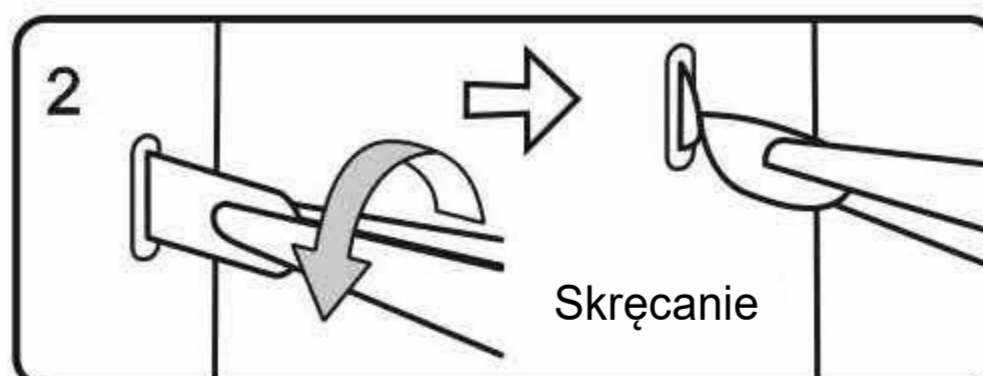

Umieść mocowanie w gnieździe, następnie skręć pod kątem 90 stopni.

Opis symboli:



Grawerowana / kolorowa strona



Nie grawerowana / srebrna strona



Zwróć uwagę podczas montażu



Zachowaj symetrię

Informacje:

1. Produkt przeznaczony dla osób w wieku od 14 lat.
2. Dzieci muszą składać model pod nadzorem osoby dorosłej.
3. Zestaw może zawierać małe elementy-ryzyko połknięcia.
4. Podczas oddzielania elementów od metalowych arkuszy, nie należy przecinać „mocowania” jako „pozycji łącznika”.
5. Wycinaj tylko części wskazane w danym kroku instrukcji.
6. Nie wycinaj wszystkich części jednocześnie, aby uniknąć pomyłki.
7. W przypadku napotkania części z linią zagięcia, należy zwrócić uwagę na przód i tył elementu oraz kierunek zagięcia.
8. Ostrożnie przetnij, a następnie powoli zagnij zgodnie z kierunkiem wskazanym w instrukcji.
9. Wielokrotne zaginanie elementów i mocowań może powodować uszkodzenia.

Rozmieszczenie elementów:

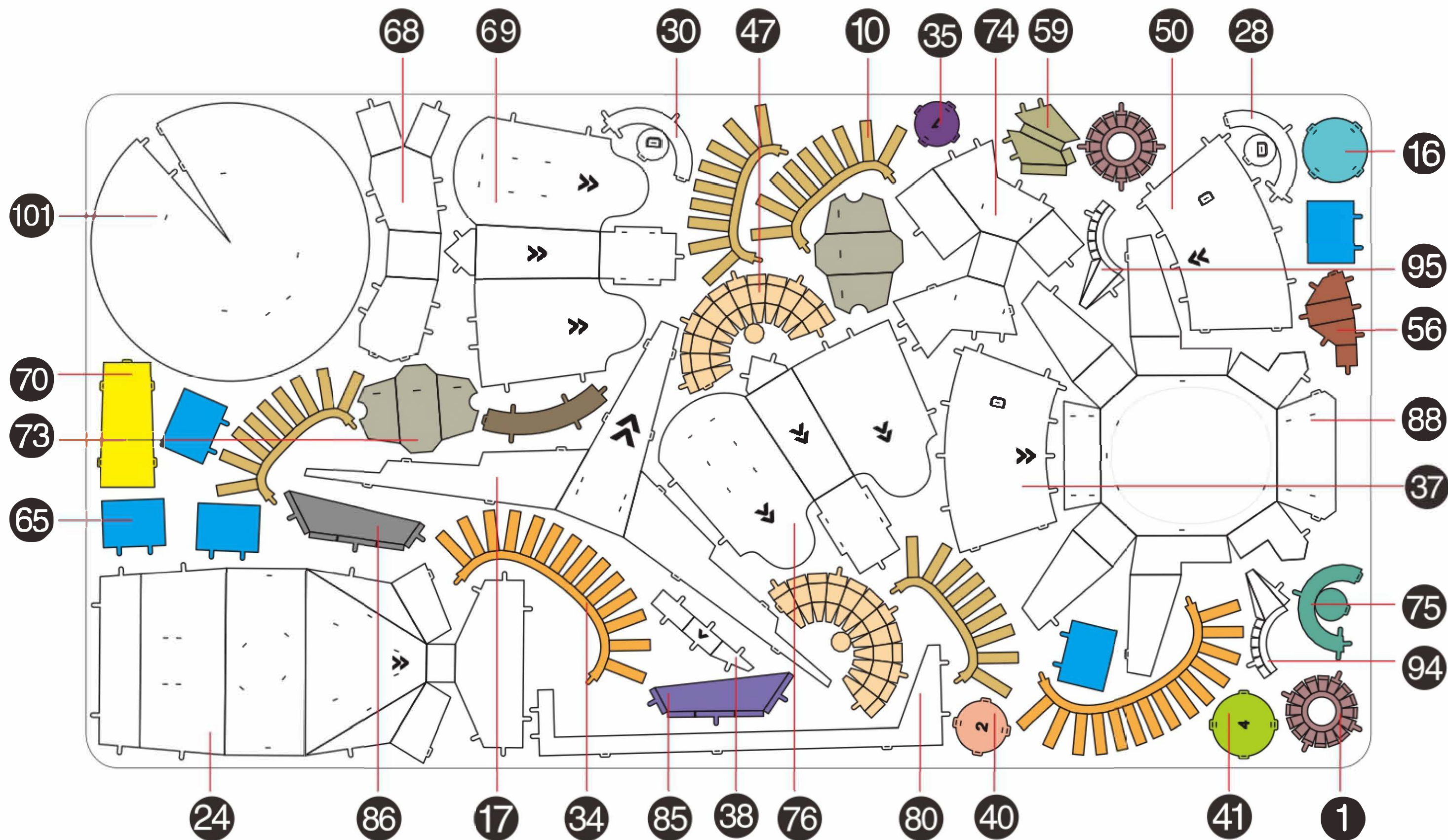

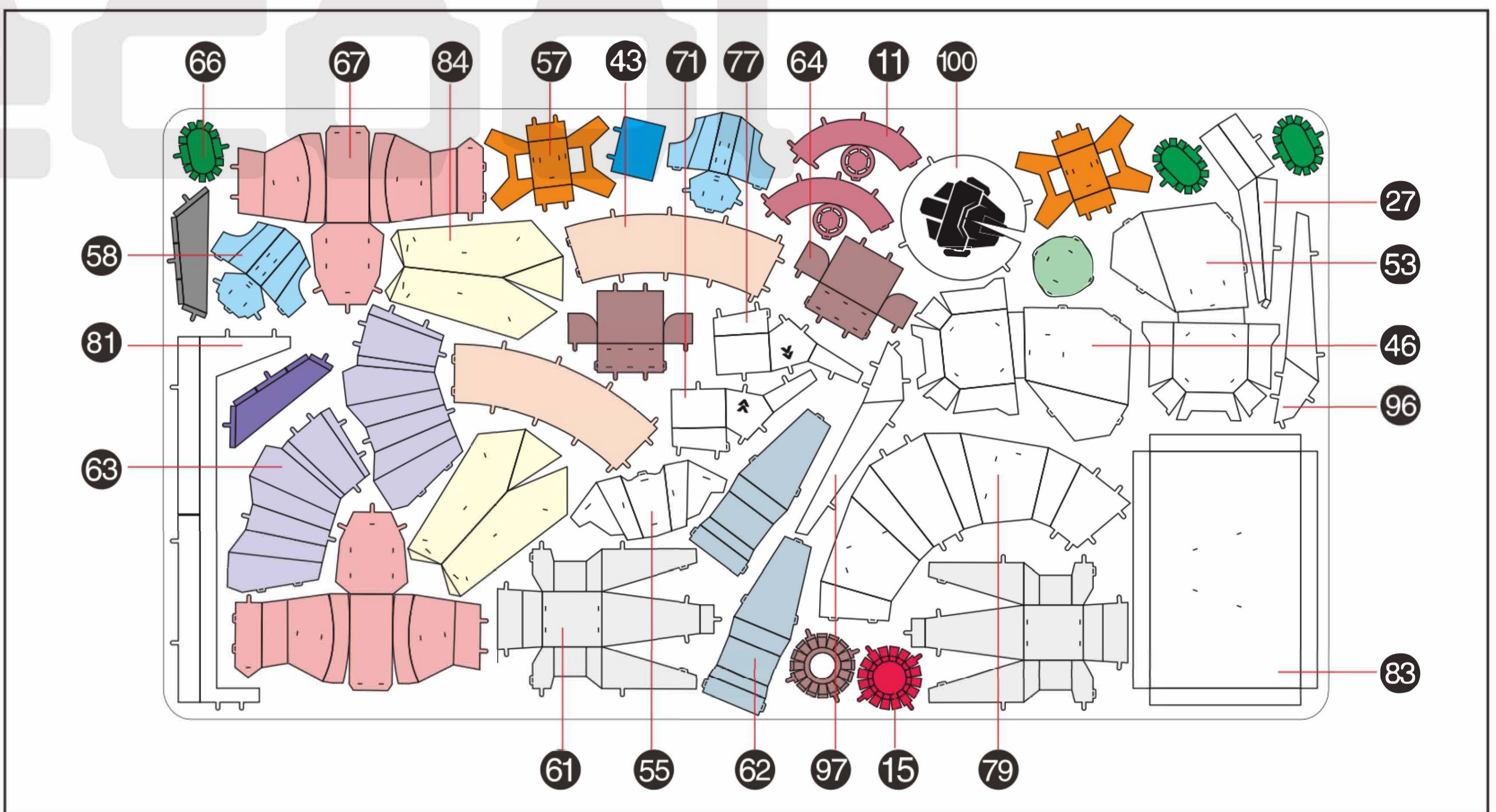
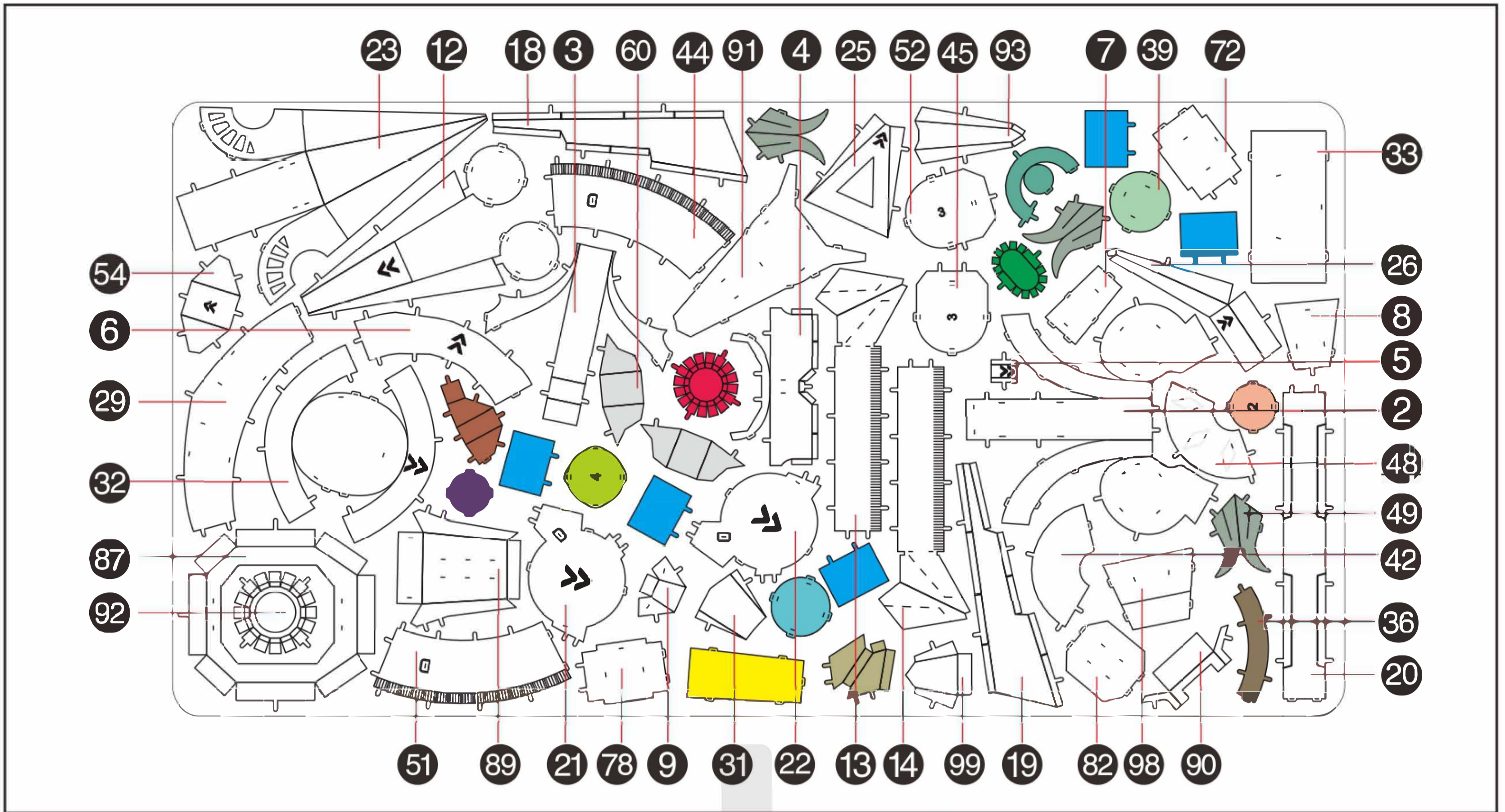

Instrukcja złożenia:

